

Amewi Transformer
Item No: 22119



Instruction Manual

CAUTION

- (1). Detachable small parts should be put away, do not let children devour.
- (2). If there is radio interference to operate the venue, please select the venue operator.
- (3). Remote control when low-power, please immediately stop the operation.
- (4). On backout after the removal, please do not place discarded to avoid contamination sanitation.
- (5). Would be grateful if your remote control model stored in dry, cool place.
- (6). Do not place near fire and high temperature, moist storage.
- (7). When the battery is water wet, add water to fully clean.

1. Product configuration

(1). Product configuration A

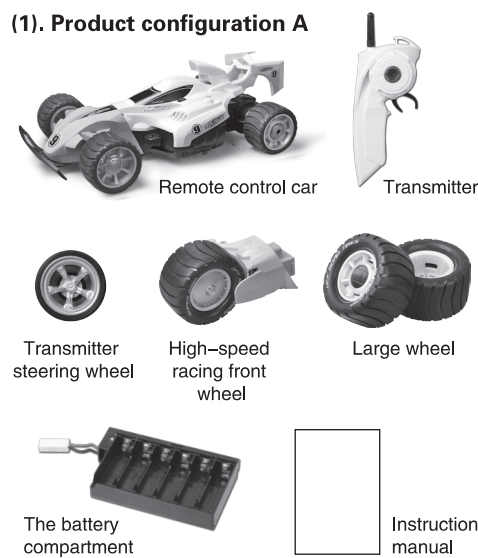

(2). Product configuration B

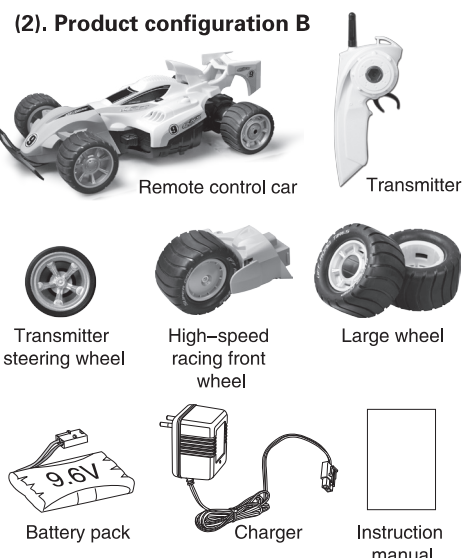

2. Assembly transmitter battery instruction

- (1). Use a philips screwdriver to loosen the screws on the battery cover by the counter-clockwise, open the battery cover.(Fig.1)
- (2). Insert 6X"AA" battery with the correct polarity.(Fig.2)
- (3). Close battery lid and lock screw tightly.(Fig.3)

NOTICE:

1. Install the battery must recognize the battery and battery box is precise plus or minus polarity, can't installation reverse.
2. Do not mix new and old batteries together when in use.
3. Please don't mix different types of batteries when in use.

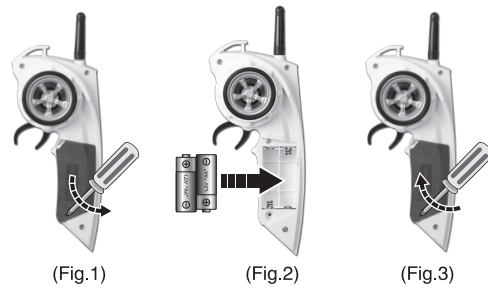

© AMEWI Trade e.K., D-33178 Borchon, Nikolaus-Otto-Str. 6, Deutschland www.amewi.com

3. Installing the remote control car battery (configuration A)

- (1). Card battery in the car base covered remove the card lock , open the battery cover ;(Fig.1)
- (2). Such as the correct polarity (Fig.2) into the six 1.5V " AA " batteries (batteries not included) ;
- (3). Close the battery cover , the card lock card in the car cradle battery cover (Fig.3).

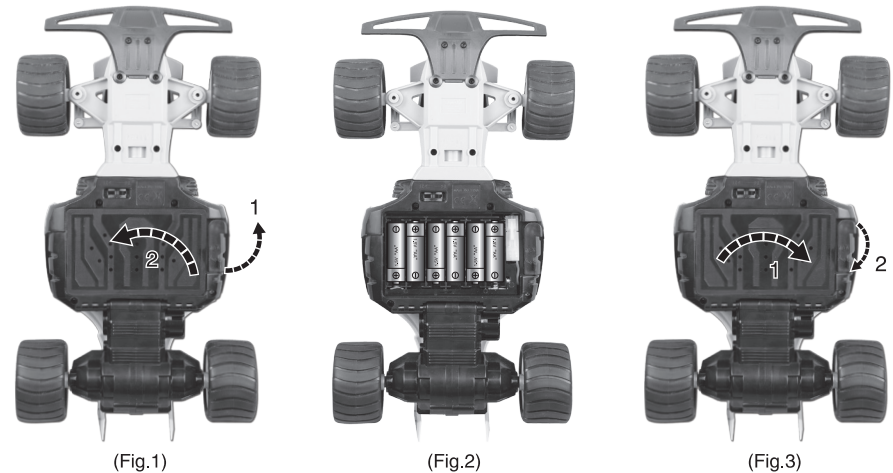

4. Charge and install the rechargeable battery pack (configuration B)

- (1). Charging the battery pack plug to connect to the charging port of the charger first , then the charger plug to the charging socket , then charge on the charger red indicator light indicates charging began, about 3-4 hours charging is completed.(Fig.1)
- (2). Will card in the car cradle battery cover remove the card lock to open the battery cover (Fig.2) ;
- (3). (Fig.3) according to the correct polarity of the battery pack socket connection to the interface of the remote control cars inside the battery compartment , then 9.6V rechargeable battery pack into the battery compartment ;
- (4). Will card in the car cradle battery cover remove the card lock to open the battery cover(Fig.4);

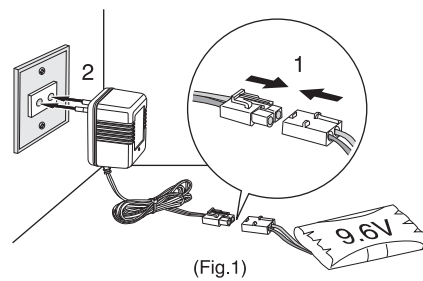

(Fig.1)

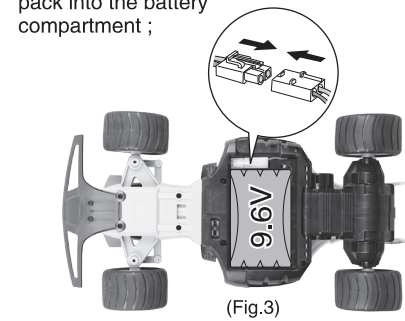

(Fig.3)

- (2). Will card in the car cradle battery cover remove the card lock to open the battery cover (Fig.2) ;

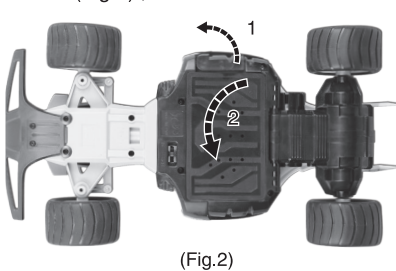

(Fig.2)

- (4). Will card in the car cradle battery cover remove the card lock to open the battery cover(Fig.4);

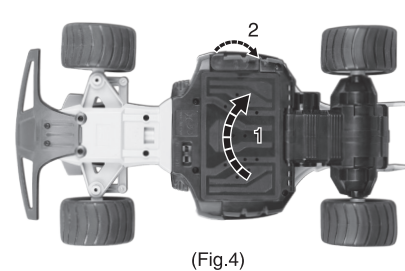

(Fig.4)

© AMEWI Trade e.K., D-33178 Borchon, Nikolaus-Otto-Str. 6, Deutschland www.amewi.com

5. Replacement parts

- (1). Replace front wheel
 - ①. Press and hold the two sides of the button in the front wheel behind .
 - ②. Pull down the front wheel;
 - ③. Replace the other front wheel.

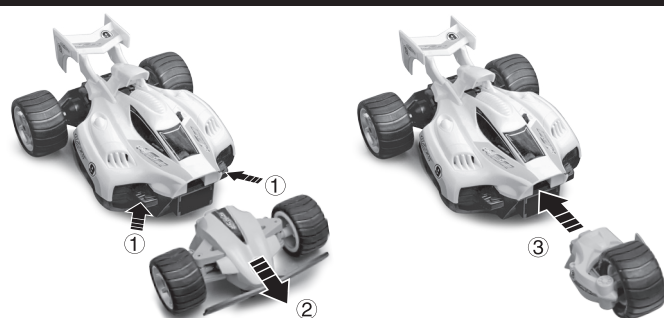

- (2). Replace the rear wheel
 - ①. Pressing the center of the wheel;
 - ②. Pull down the wheel;
 - ③. Replacement of wheel .



6. Transmitter steering wheel

The steering wheel can be placed in the left or right side of the transmitter to adapt to the habits of the players .

- (1). The transmitter power switch to "OFF" position . (Figure 1)
- (2). Remove the steering wheel on it for your habits. According to the current settings , left/right wheel set switch position corresponding to the steering wheel . (Figure 2)

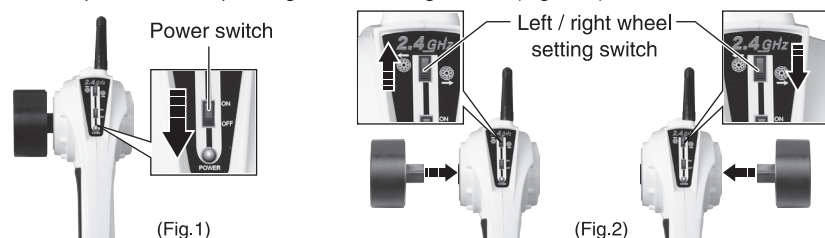

(Fig.1)

(Fig.2)

7. Control the car

1. Put the steering wheel in the transmitter.
2. Transmitter and the frequency of the vehicle set:
 - (1). First set, the car and transmitter supply must be in 4 seconds at the same time open, let them check frequency (Proofing, car and remote control power indicator will flash, when proofreading is completed, president of the power indicator light); (Fig.1)
 - (2). If because not enough time and on the frequency, to turn off the car and transmitter power, then please repeat the first (1) point set of frequency.



(Fig.1)

! Note:

When the lack of the power of remote control cars and transmitter , power indicator light flashes, this should replace the battery or rechargeable battery pack to recharge your batteries.

© AMEWI Trade e.K., D-33178 Borchon, Nikolaus-Otto-Str. 6, Deutschland www.amewi.com

3. With fingers throw the transmitter throttle back, racing forward corresponding exercise; forc with your fingers apart the transmitter accelerator, the car back corresponding exercise.(Fig.2)

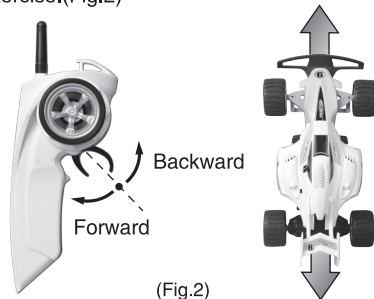

(Fig.2)

4. When the throttle control car, and turned the steering wheel, can control the car left/right turn. (Fig.3)

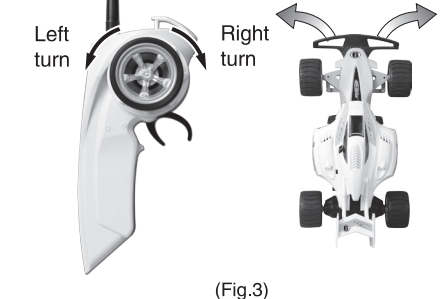

(Fig.3)

8. Trimmer

Direction regulate control rod:
When model does not run in a straight line, you can move it through the button steering trim control trigger on the button. When model goes to the right, press "L" (left) trim button, when the model movesto the left, press "R" (right) button until the model moves in a straight line.

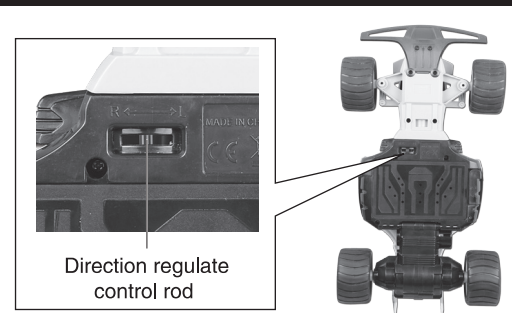

Direction regulate control rod

! WARNING

- Batteries are to be inserted with the correct polarity.
- Non-rechargeable batteries are not to be recharged.
- Rechargeable batteries are to be removed from the product before being charged
- Rechargeable batteries are only to be charged under adult supervision.
- Different types of batteries or new and used batteries are not to be mixed.
- Exhausted batteries should be removed from the product.
- The supply terminals are not to be short-circuited.
- Operation, the hand can not come into contact with the transmitter antenna, Otherwise it will affect the remote distance; broken antenna need to be handled by adults .
- This car with a powerful driving force , high speed, due to the inertia of the reasons, not slam the brakes , use the special attention to .
- When the car speed is slowed down when the body battery is low . Please racing by the above method to recharge .
- When charging please look for the charging plug and charging port .
- Remove batteries if the product is not to be used for an extended period.
- Unpacked under the guidance of the adult .
- The packaging has to be kept since it contains important information.

© AMEWI Trade e.K., D-33178 Borchon, Nikolaus-Otto-Str. 6, Deutschland www.amewi.com